

Varenummer: 203350M16200B1U

Beskrivelse: E+G Justerfod  
GN 33-50-M16-200-B1-U, Rustfast

Note: U Uden møtrik, sekskant i toppen, spændeflade i bunden

## Mål

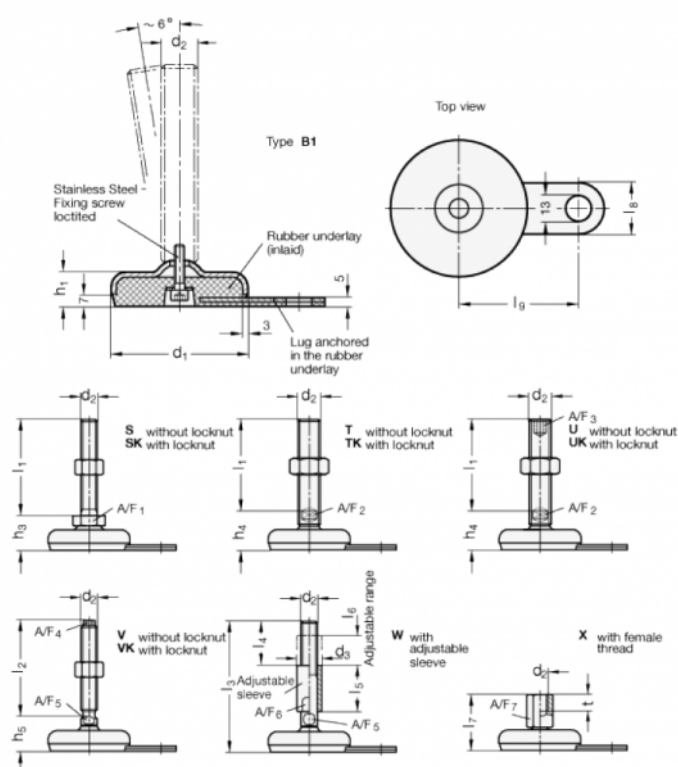

A/F2 = 12

I9 = 45

A/F3 = 8

d1 = 50

d2 = M16

h1 = 18

h3 = 32

l1 = 200

l8 = 25